

Инструкция по сборке Instructions for assembling furniture Instrukcja montażu mebli

Набор мебели для Collection Kolekcja mebli
общей комнаты «PROVENCE»

Шкаф открытый 1D1S
Cupboard 1D1S
Regał otwarty 1D1S

AH-044.16.00.00

Шкаф 2D1S
Cupboard 2D1S
Szafa 2D1S

AH-044.15.00.00

Шкаф с витриной 1V1D1S
Cabinet-showcase 1V1D1S
Szafa-witryna 1V1D1S

AH-044.17.00.00

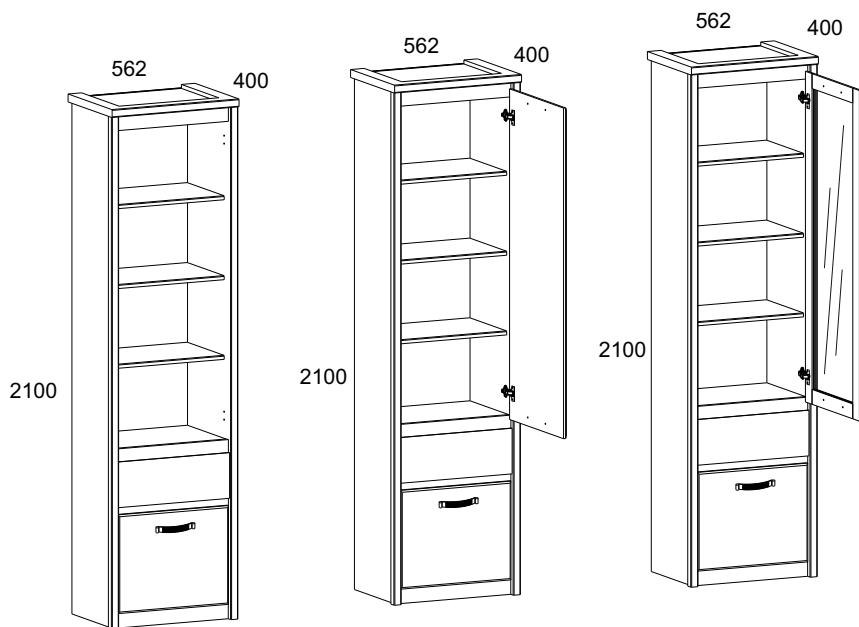

Дата изготовления
Production date
Data produkcji

Штамп ОТК
Stamp of Quality Department
Pieczęć Działu Jakości

ИООО «АНРЭКС»
Республика Беларусь, 224004
г.Брест, ул. Катин Бор, 119
тел/факс (+375162) 29-74-68



ЕАЭС №BY/112 11.01. TP025 018 04704
от 03.05.2019
по 02.05.2024

Инструкция по эксплуатации.

Качество и комплектность изделия рекомендуется проверять в магазине при покупке в распакованном виде. Сборка изделия должна производиться в порядке, изложенном в настоящей инструкции. В процессе эксплуатации изделий необходимо периодически затягивать ослабленные винтовые соединения. В случае необходимости перемещения изделия по квартире перед его перестановкой, необходимо полностью освободить его от груза (матраца). Во избежание поломки имеющихся опор передвигать производить приподнимая изделие над уровнем пола. Запрещён прямой контакт с водой. Удаление пыли с изделий следует производить слегка влажной мягкой салфеткой. Во избежание коробления деталей и изменения цвета изделия следует избегать установки мебели на прямых солнечных лучах.

При эксплуатации изделий набора **ЗАПРЕЩАЕТСЯ**:

- устанавливать мебель вблизи отопительных приборов и вплотную к сырým стенам и в помещениях с относительной влажностью более 70%;
- температура нагрева элементов мебели не должна превышать +40 °С.
- в процессе сборки и эксплуатации изделий набора становиться ногами на горизонтальные щиты и витрины;
- применять химические чистящие средства для уборки мебели;

Гарантии изготовителя

1. Гарантийный срок эксплуатации изделия - 24 месяца со дня продажи магазином. В период гарантийного срока изготовитель гарантирует ремонт изделий или их замену, если потребителем не нарушены правила эксплуатации.
2. Претензии предъявляются потребителем непосредственно в торгующую организацию, в которой была приобретена мебель, предъявив настоящую "Инструкцию по сборке" и копию товарного чека.
3. Изделия **Шкаф открытый 1D1S, Шкаф 2D1S, Шкаф с витриной 1V1D1S**, входящие в состав набора мебели для общей комнаты **«PROVENCE»**, соответствует требованиям ГОСТ 16371-2014, ТР ТС 025/2012.
4. Срок службы мебели - 5 лет.
5. Предприятие-изготовитель оставляет за собой право вносить изменения в конструкцию изделия, не ухудшая его конструктивные и эксплуатационные характеристики.
6. Для сборки изделий рекомендуется привлекать квалифицированных специалистов.

Важно! Сохраните, пожалуйста, инструкцию в случае повторной сборки мебели или рекламации. В случае составления рекламации пользуйтесь, пожалуйста, обозначением из инструкции сборки.

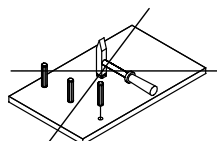
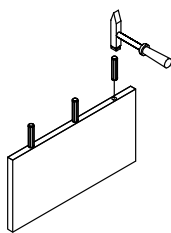
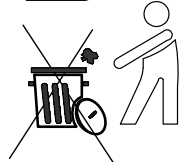

PL

Przy eksploatacji mebli zabrania się:

- ustawiać meble w pobliżu grzewczych przyrządów i obok wilgotnych ścian, a także w pomieszczeniach ze względną wilgotnością więcej niż 70%;
- temperatura nagrzewania elementów mebli nie może przekraczać +40°C;
- w trakcie montażu i eksploatacji mebli stawać nogami na poziome panele i witryny;
- stosować chemiczne środki czyszczące do sprzątania mebli;
- nie należy narażać na kontakt z wodą.

Gwarancja producenta

1. Gwarancyjny termin eksploatacji wyrobu - 24 miesiące z dnia sprzedaży. W okresie gwarancyjnego terminu producent gwarantuje naprawę wyrobów lub ich zamianę, jeżeli reguły eksploatacji nie zostały naruszone przez nabywcę.
2. Roszczenia są przekazywane przez nabywcę bezpośrednio do handlującej organizacji, w której były nabyte meble, tylko przy okazaniu danej "Instrukcji montażu" wraz z dokumentem zakupu.
3. Wyróby **Regał otwarty 1D1S, Szafa 2D1S, Szafa-witryna 1V1D1S**, wchodzące w zestaw mebli **"PROVENCE"**, odpowiada wymaganiom Norm Państwowych 16371-2014, TP TC 025/2012
4. Trwałość użytkowa mebli - 5 lat.
5. Firma-producent pozostawia za sobą prawo do wprowadzania zmian w konstrukcje wyrobów, nie pogarszając ich konstruktywne i eksploatacyjne charakterystyki.
6. Do montażu wyrobów zaleca się skorzystanie z pomocy wykwalifikowanych specjalistów.

Ważne! Proszę zachować instrukcję w razie ponownego montażu mebli lub reklamacji. Podczas składania reklamacji prosimy o korzystanie z oznaczeń z instrukcji.

EN

Instruction manual.

It's advised to check the quality and completeness of the product in the store when buying unpacked. Assembling of the product should be done the way it's described in this manual. While the product is in service loose screw connections should be periodically tightened. If it's necessary to move items around the apartment before moving you should release the product completely from the load (the mattress). To prevent damage to existing supports the product should be lifted before moving. Furniture should not be exposed to contact with water. Dusting the product should be done with a slightly damp soft cloth. To prevent warping of parts and discoloration of products do not install furniture in direct sunlight.

While the product is in service it's PROHIBITED TO:

- Install furniture near heating devices, close to the raw walls and in rooms with a relative humidity of more than 70%;
- heat elements of furniture to the temperature higher +40°C;
- step on the horizontal shields and windows during assembly and use of the products set;
- use chemical cleaners for cleaning furniture;

Manufacturer's warranty.

1. The warranty period of use of the product - 24 months from the date of sale. During the warranty period the manufacturer guarantees repair or replacement of products, if the user has not violated operating rules.
2. Claims should be made by the consumer directly to the trading organization, in which furniture was purchased, presenting the "Instruction manual" and a copy of the sales receipt.
3. The products, **Cupboard 1D1S, Cupboard 2D1S, Cabinet-showcase 1V1D1S**, which are part of a set of **"PROVENCE"**, meets the requirements of GOST 16371-2014, TR TS 025/2012.
4. The lifetime of furniture - 5 years.
5. The manufacturer reserves the right to make changes in product design, without compromising its design and application requirements.
6. To assemble the products it's recommended to attract qualified personnel.

It is important! Keep the instruction in case of reassembly of furniture or complaint. When making a claim use the notation from the instruction.







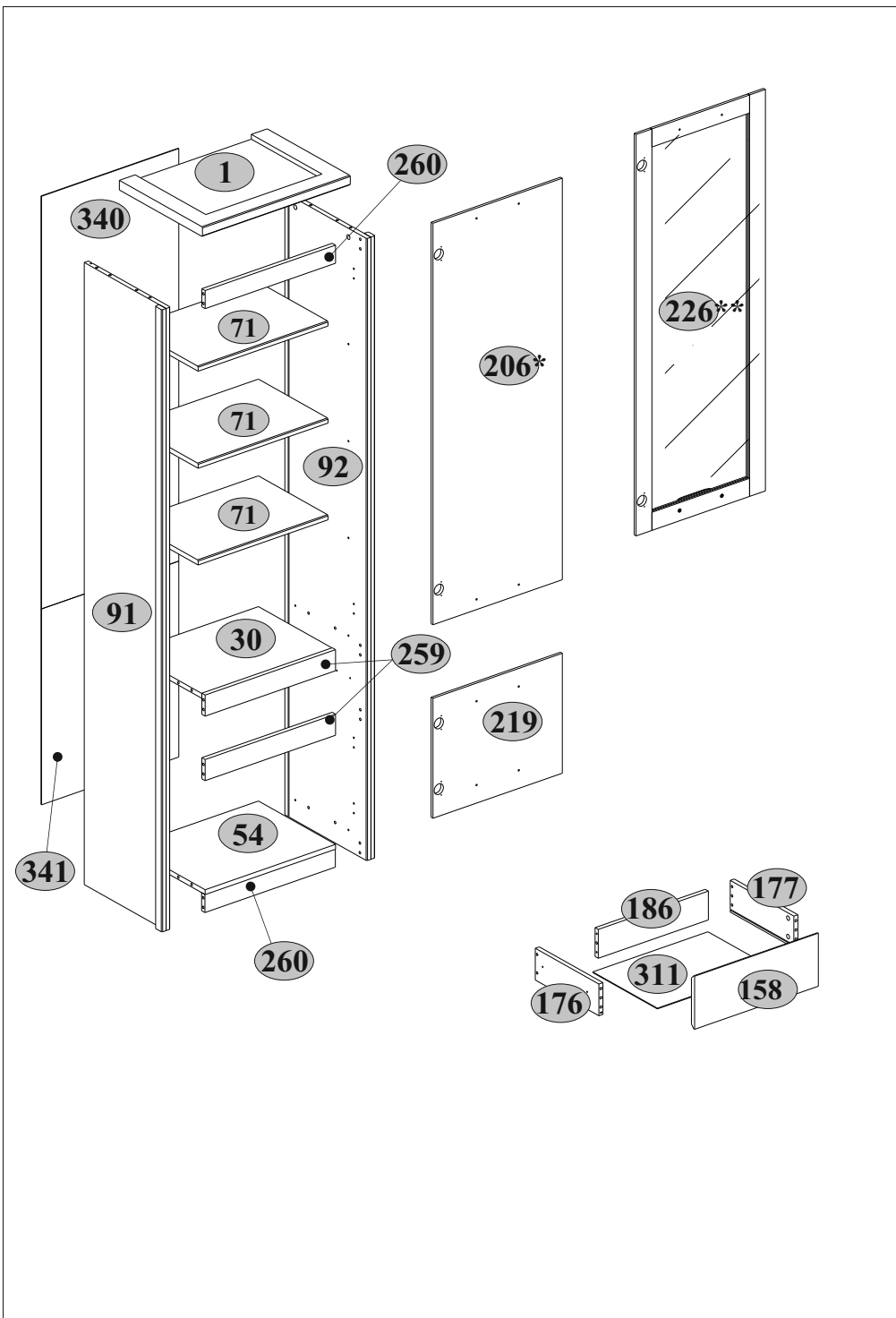

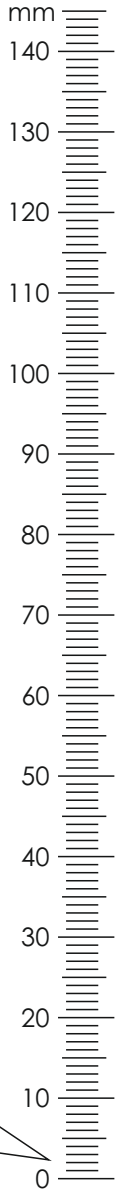















№ п/п	Длина мм.	Ши- рина мм.	Тол- щина мм.	Кол- во шт.	№ пачки		
						*	**
1	562	400	32	1	1/3	1/4	1/4
30	494	335	16	1	1/3	1/4	1/4
54	494	351	16	1	1/3	1/4	1/4
71	492	315	16	3	1/3	1/4	1/4
91	2064	394	32	1	2/3	2/4	2/4
92	2064	394	32	1	2/3	2/4	2/4
158	490	184	16	1	1/3	1/4	1/4
176	320	110	16	1	1/3	1/4	1/4
177	320	110	16	1	1/3	1/4	1/4
186	436	100	16	1	1/3	1/4	1/4
206	490	1332	16	1	-	4/4	-
219	490	398	16	1	1/3	1/4	1/4
226	1332	490	16	1	-	-	4/4
259	494	70	16	2	1/3	1/4	1/4
260	494	60	16	2	1/3	1/4	1/4
311	456	325	2,5	1	3/3	3/4	3/4
340	1358	506	2,5	1	3/3	3/4	3/4
341	652	506	2,5	1	3/3	3/4	3/4

Шкаф 2D1S
 *- Cupboard 2D1S
 Szafa 2D1S

Шкаф с витриной 1V1D1S
 **- Cabinet-showcase 1V1D1S
 Szafa-witryna 1V1D1S





A1  16	A2  16	B5  10x50 1	C1  8x35 32
D1  2(4*,4**)	E6  2(4*,4**)	I  1	KL  1
H17  1(2*,2**)	M4  M4x22 2(4*,4**)	N1  4	P1  12
Q  3(6*,6**)	R3  3x20 9	R23  6,3x13 4(8*,8**)	R24  7x50 4
R27  5,0x13 10	R102  3,5x16 6(10*,10**)	S1  16	S3  3
S5  8	S11  8	U  1	Z10  300 1

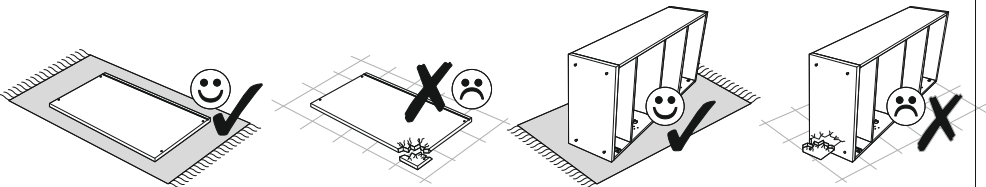
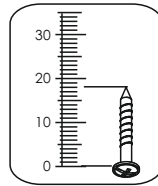
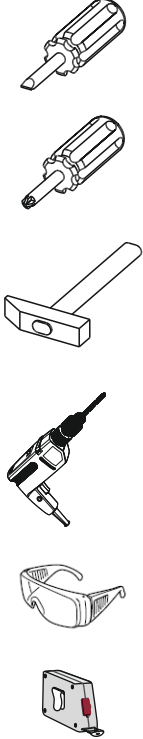

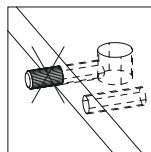
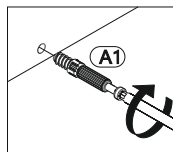
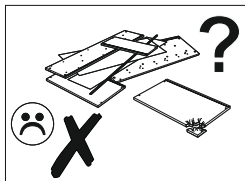



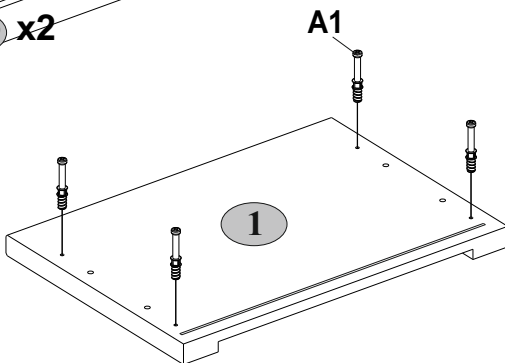
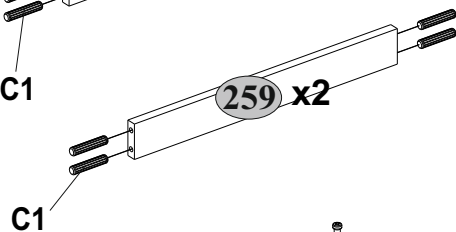
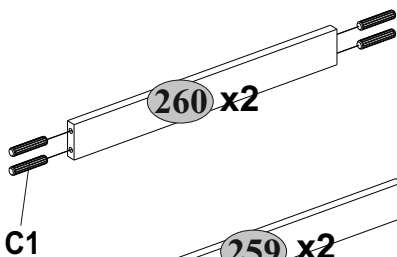
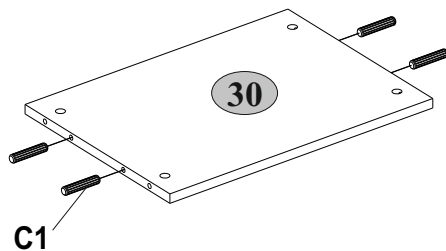
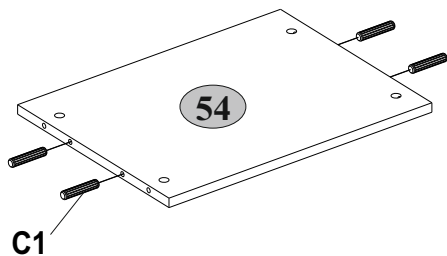
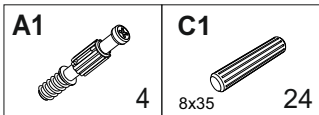





1



2

A1  8	C1  8x35 4	D1  2(4*,4**)	N1  4	P1  12
R23  6,3x13 4(8*,8**)	R27  5,0x13 6	S11  8	Z10  300 1	

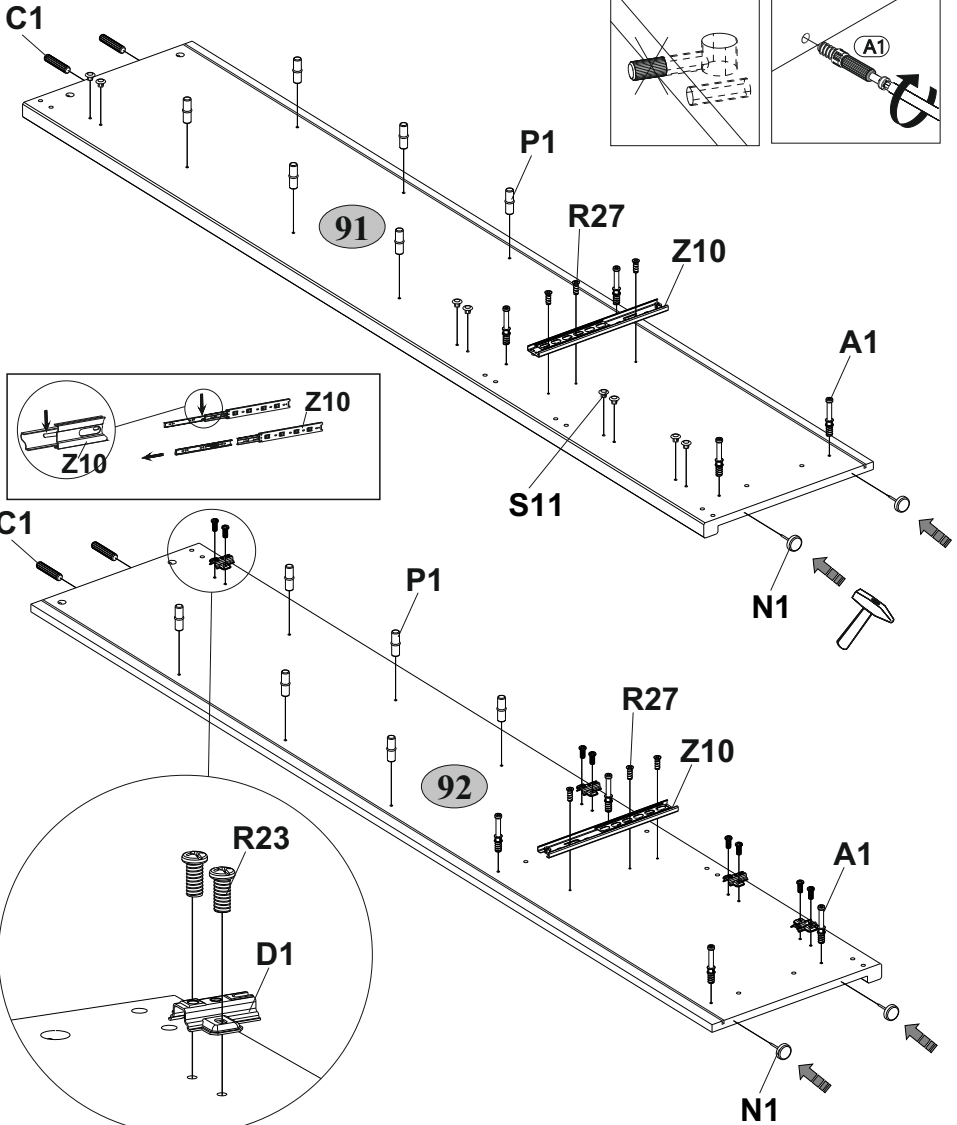

3

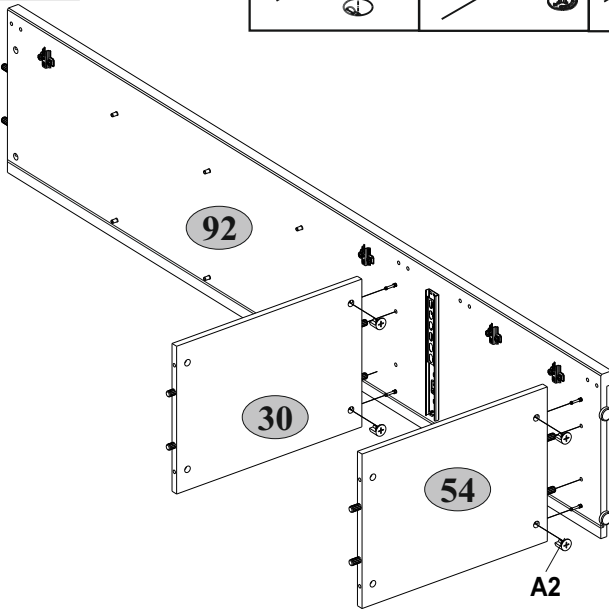
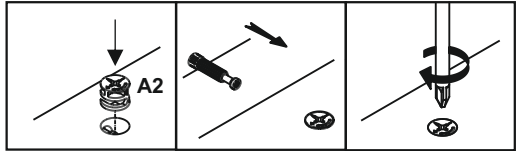
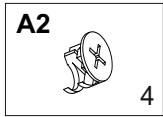

4

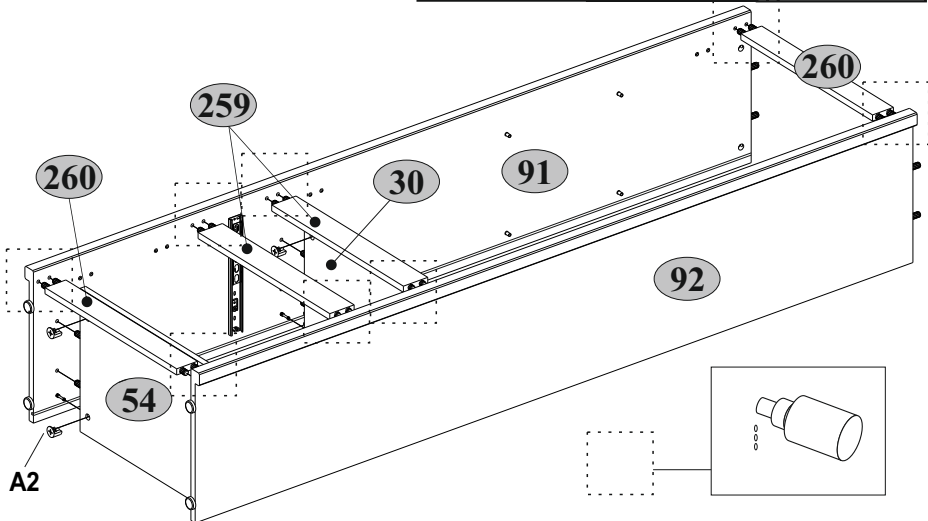
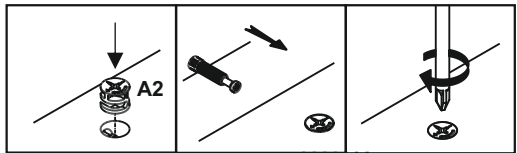
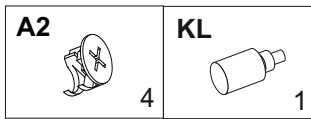

5

A2



4

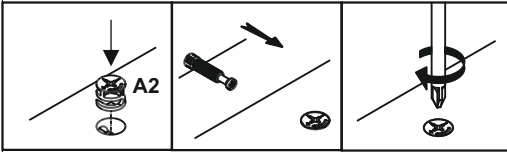
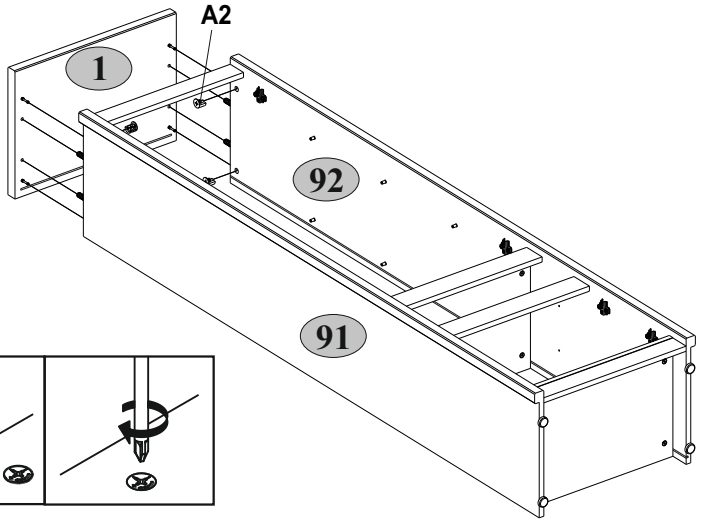

6

S1



16

S3

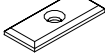

3

R3



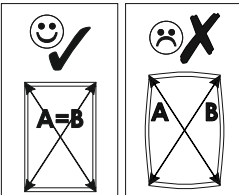
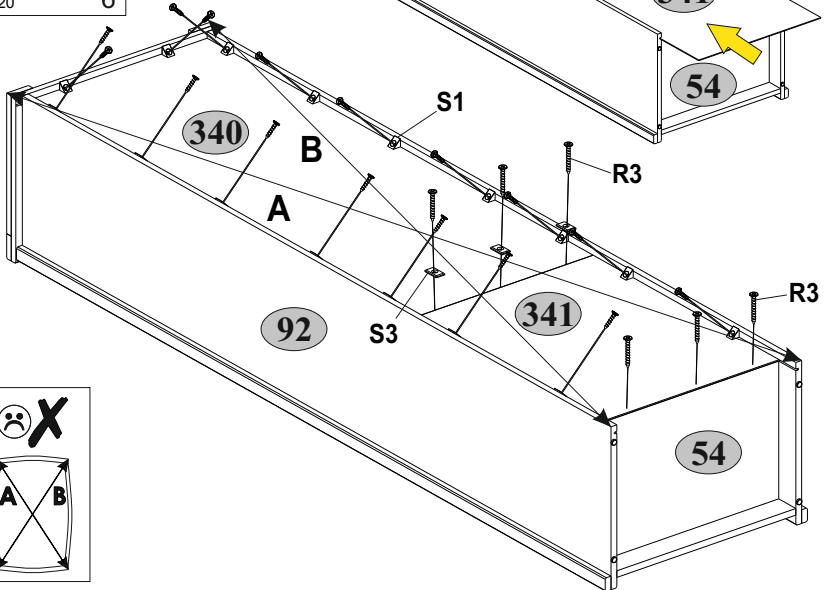
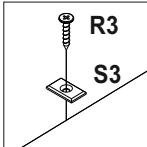
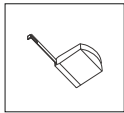
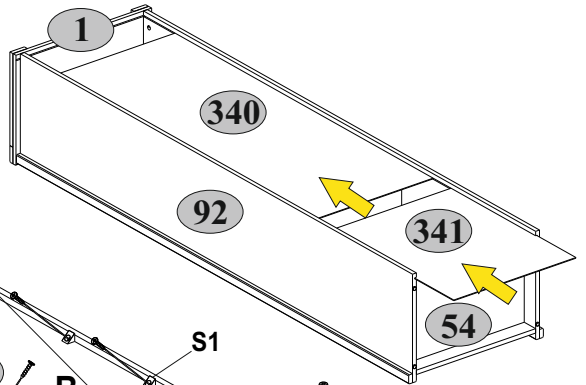

3x20

6



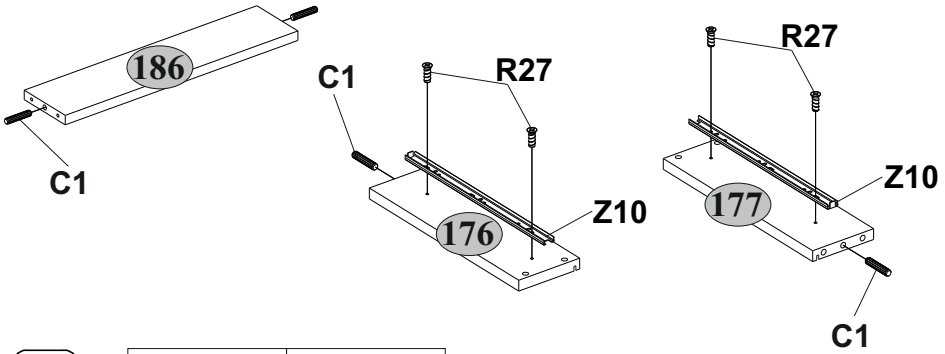
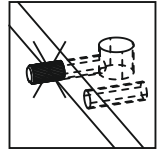
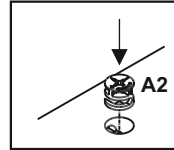

7

C1  8x35	R27  5,0x13	Z10  300
4	4	1



8

I  1	R24  7x50
1	4

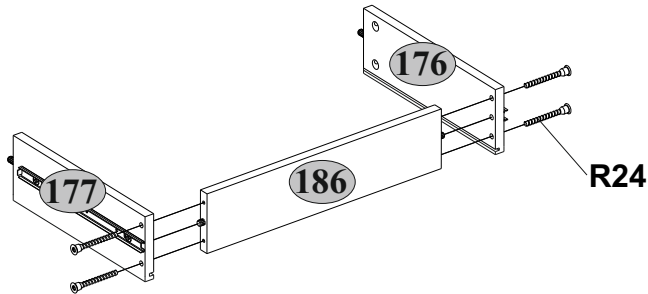
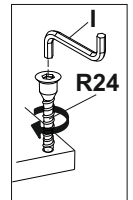

9

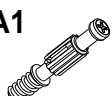
A1  4
4

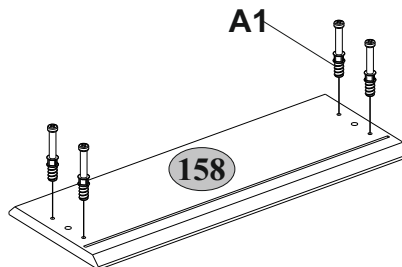
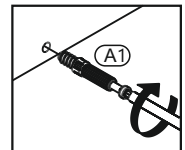

10

A2



4

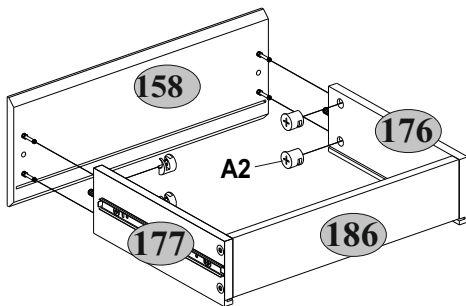
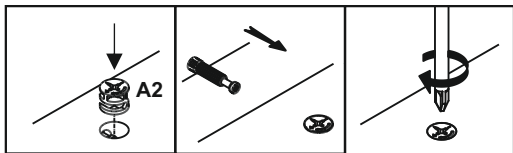

11

R3



3x20

3

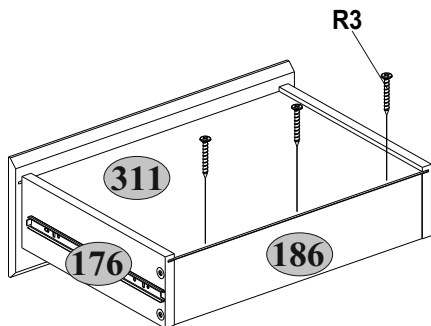
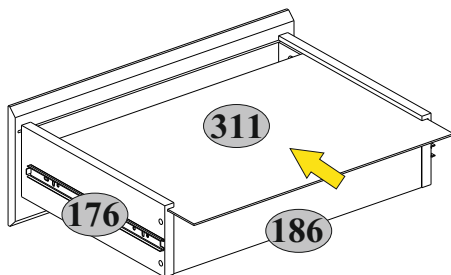

12

E6



2

H17



1

M4



M4x22

R102





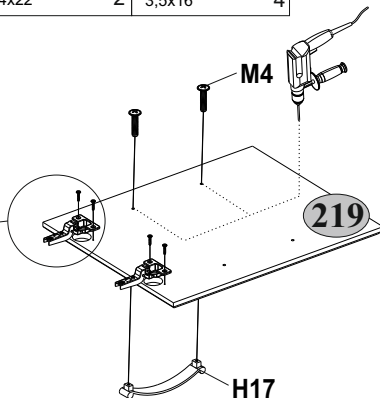
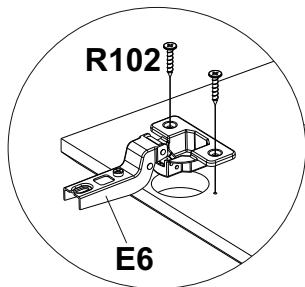

2 3,5x16





4

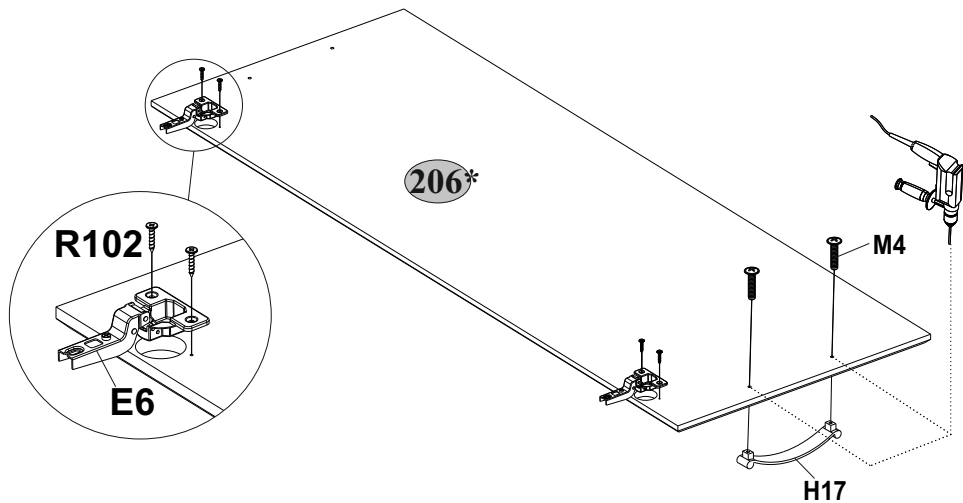

13

E6  2*	H17  1*	M4  M4x22 2*	R102  3,5x16 4*
--	---	--	---

**14**

E6  2**	H17  1**	M4  M4x22 2**	R102  3,5x16 4**
---	--	---	--

